



**User Manual for
uTrust TS MULLION
Physical Access Control Readers**

Version 1.4

Document number: 80x003

Confidential

TouchSecure® Mullion User Manual

Version History

Date	Version	Description of Changes	Author
10-July-15	1.0	Initial version	Suresh Kumar T
8-Oct-15	1.1	Updated Wiegand cable details	Sixtus
20-Nov-15	1.2	Updated input voltage range and added document number	Sudhan
10-Dec-2015	1.3	Current ratings updated as per comments from UL	Sudhan
14-Dec-15	1.4	Document updated as per review comments from UL	Sudhan

TouchSecure® Mullion User Manual

Contents

1.0	Introduction	4
2.0	Reader	4
2.1	Functionality.....	4
2.2	Top Casing	4
2.3	TouchSecure® reader with Bottom Casing	5
2.4	Reader Variants.....	5
3.0	Product details	6
4.0	Reader Specifications.....	6
4.1	Rated current at different operating voltages	7
4.1.1	Rated current for Model 8000.....	7
4.1.2	Rated current for Model 8010.....	7
4.1.3	Rated current for Model 8030.....	8
4.1.3.1	Rated current for 6-16V input.....	8
4.1.3.2	Rated current for POE.....	9
5.0	Installation details	10
5.1	Parts List.....	10
5.2	Recommended Infrastructure	10
5.3	Wiring Information.....	10
5.3.1	Cable Color codes for Pig Tail Reader.....	10
5.3.2	Pin out for Phoenix Connector Reader	10
5.4	Mounting the Reader	11
5.4.1	Location of mounting holes on wall	11
5.4.2	Reader Installation Steps	12
5.5	Power up and Testing.....	14
6.0	Certifications	14
6.1	FCC.....	14
6.2	IC	14
6.3	CE	14
6.4	UL 294	15
6.4.1	UL 294 access control performance levels	15

TouchSecure® Mullion User Manual

1.0 Introduction

This document details the Physical Access Control Reader TouchSecure® and its basic operational and installation procedures. It covers the details of the Mullion form-factor reader.

Model: Connectivity/Standard MUL

The reader comes in two variants for interfacing with the control panel

- Pigtail – 8000ABP, 8010ABP
- Phoenix connectors – 8000ABT, 8010ABT, 8030ABC
- P-refers to Pigtail, T- refers to Terminal (Phoenix header)

The reader comes in three variants in functionality

- Standard HF Only - 8000ABP, 8000ABT
- Standard HF LF - 8010ABP, 8010ABT
- Connectivity HF LF - 8030ABC
- P-refers to Pigtail, T- refers to Terminal (Phoenix header), C- refers to connectivity
- In connectivity, Only Terminal version is available.

2.0 Reader

2.1 Functionality

TouchSecure reader is a physical access control smart card reader that can read HF and LF contactless credentials, conforming to the following standards: ISO 14443 A & B, ISO15693. The reader can interface with an access control system equipped with a Wiegand or RS485 serial interface

The reader consists of the following main parts.

2.2 Top Casing

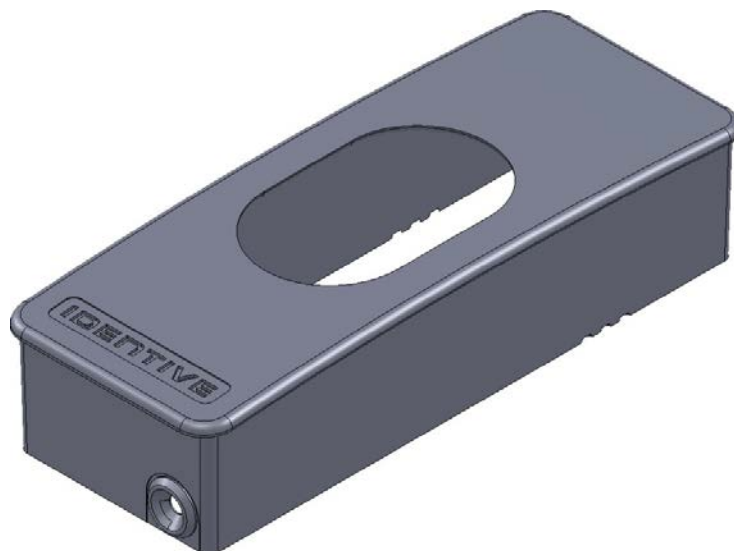

TouchSecure® Mullion User Manual

2.3 TouchSecure® reader with Bottom Casing

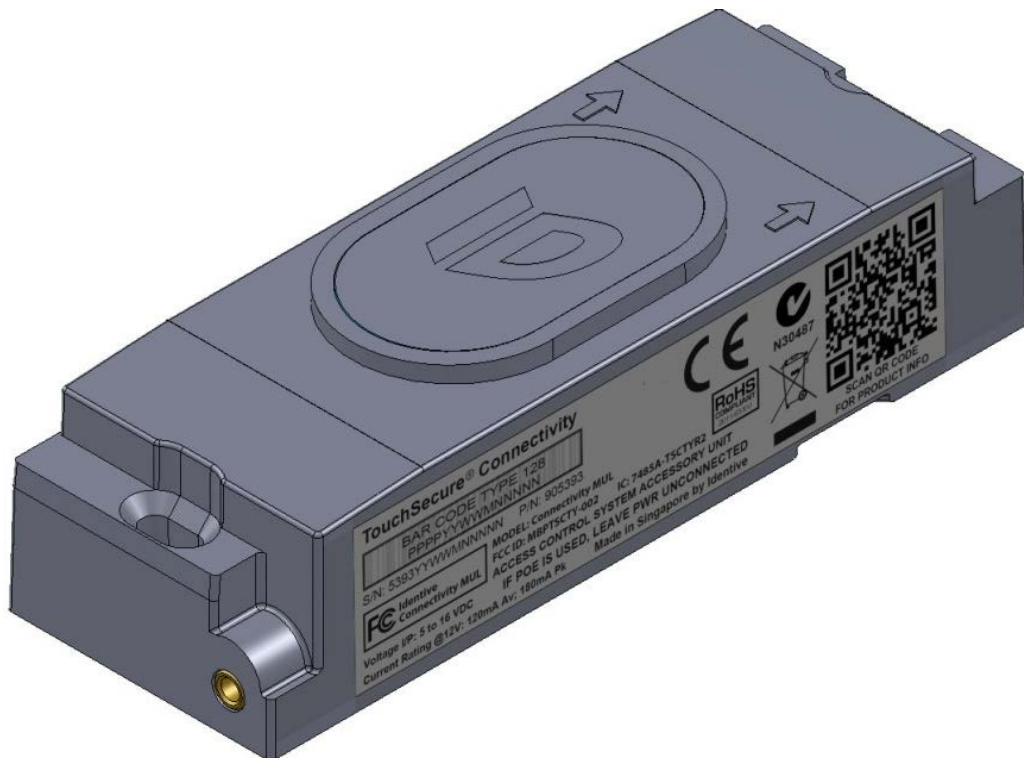

2.4 Reader Variants

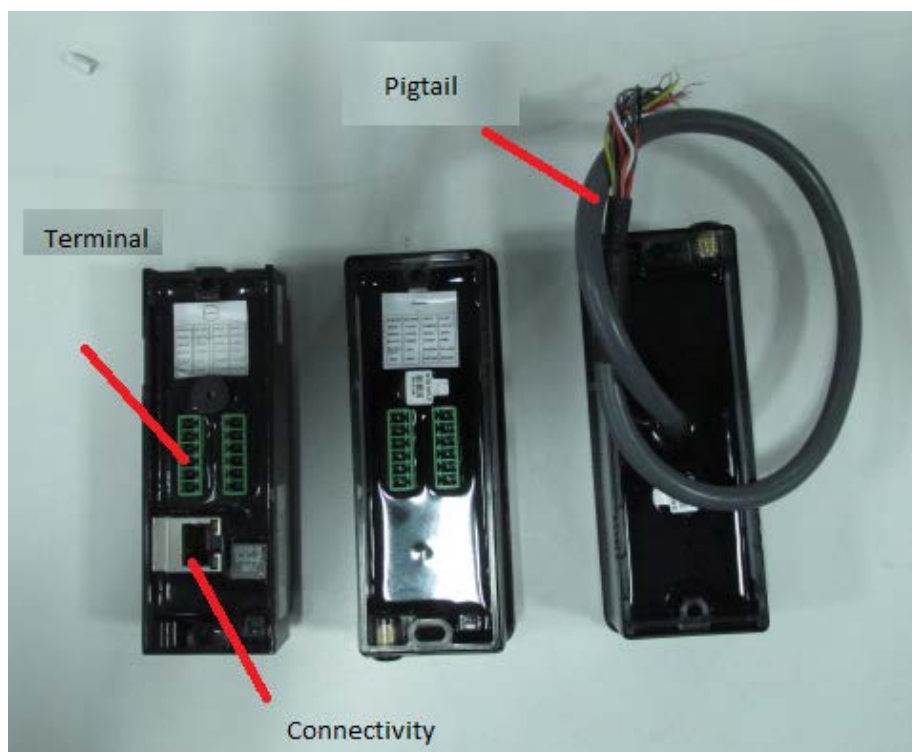

TouchSecure® Mullion User Manual

3.0 Product details

Model Name	: Connectivity/Standard MULLION
Device Type	: RFID reader, 13.56MHz (HF) / 125 KHz (LF) Physical Access control Reader (accessory equipment)
Type of equipment	: Potted reader. Suitable for Indoor use – 8030ABC and Outdoor use – 8000ABP, 8000ABT, 8010ABP, 8010ABT
Interface Type	: Pigtail Cable (11 Core + Drain) or Phoenix connectors and RJ45
Voltage Rating (8030ABC)	: 6-16V DC or 48VDC on RJ45 Connector
Voltage Rating (All other models):	5-16V DC
Communication protocol	: Wiegand, RS485 (2wire - Half Duplex), 10BaseT ETH

* Communication via Wiegand was evaluated by UL and serves as the interface between the reader and panel. Communication via RS485, OSDP or Ethernet was not evaluated by UL

4.0 Reader Specifications

Model	Operating Voltage	Current rating	Operating temp
8000ABP 8000ABT STANDARD HF ONLY	5-16 VDC	Refer graph in section 4.1	-35 to +65 Deg C
8010ABP 8010ABT HF LF	5-16 VDC	Refer graph in section 4.1	
8030ABC HF LF CONNECTIVITY	6-16 VDC	Refer graph in section 4.1	0 to +49 Deg C
	POE@ 48VDC		

* POE sourcing equipment shall be UL 294 or UL 294B Listed with Class 2 output

- When the readers use POE as a power source, the power input wiring from the control unit (i.e. Red and Black for 8030) shall be disconnected
- The maximum length of the Ethernet cable when using POE as the power source in UL installations is limited to 30 meters (98.5 feet)
- There shall be no connections made to the RS-485 interface (RS485+ and RS485-) for UL installations

TouchSecure® Mullion User Manual

Note: Standby Power is not provided by the Card Readers. The Standby Power Level is dependent on the external power source connected to the Card Reader.

- All wiring or cables to the Card Readers shall be the shielded type
- Only UL Listed POE sourcing equipment, or UL Listed power-limited power supply, or power-limited output from UL Listed control panel shall be used for the Power-Over-Ethernet feature. Cat 5e cabling is the minimum performance category recommended. These Card Readers when using POE feature are not intended for outside wiring as covered by Article 800 of the US National Electrical Code, NFPA 70.

4.1 Rated current at different operating voltages

4.1.1 Rated current for Model 8000

Voltage (V)	Average Current (mA)	Peak Current (mA)
5	150	187
8	159	208
10	122	164
12	100	133
14	87	118
16	77	103

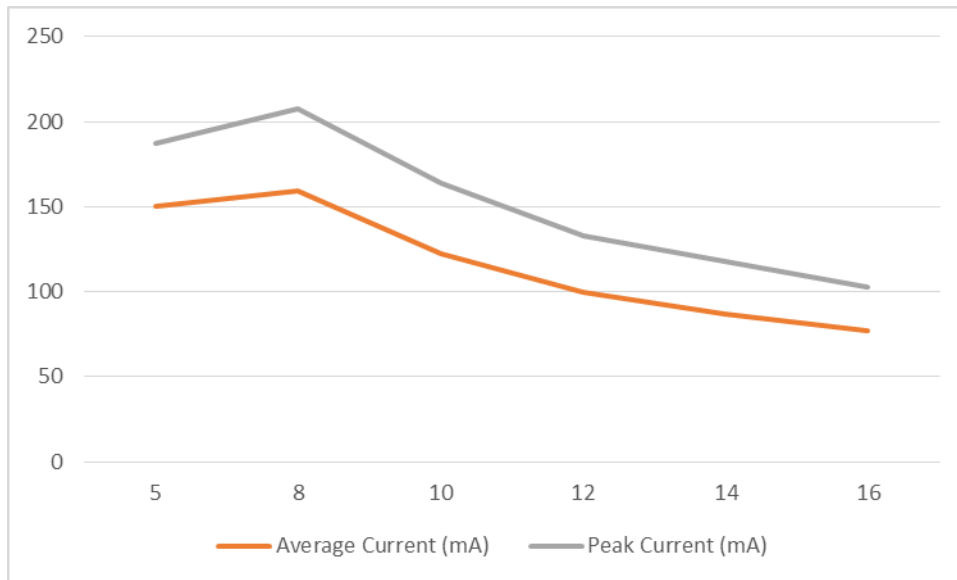

4.1.2 Rated current for Model 8010

Voltage (V)	Average Current (mA)	Peak Current (mA)
5	150	187
8	159	208
10	122	164
12	100	133

TouchSecure® Mullion User Manual

14	87	118
16	77	103

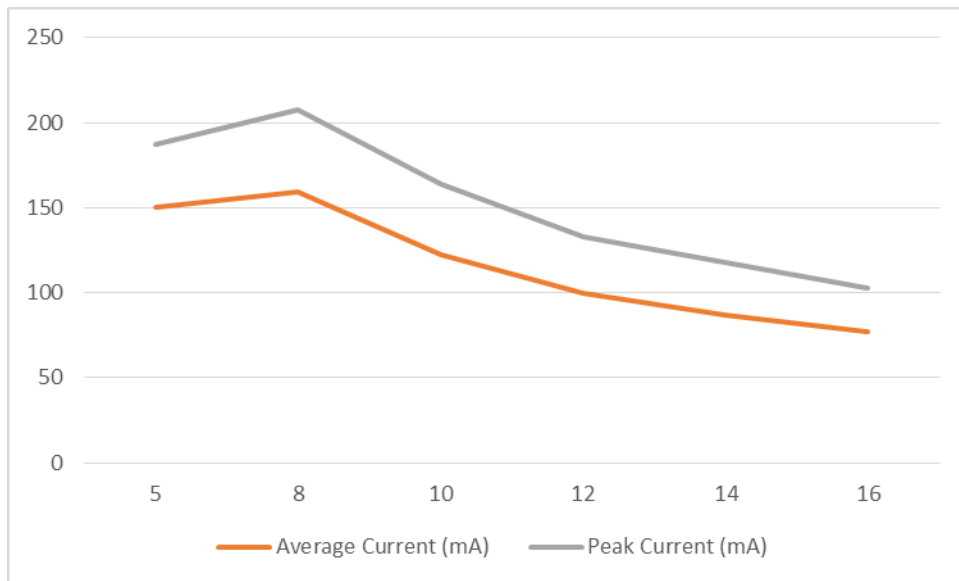

4.1.3 Rated current for Model 8030

4.1.3.1 Rated current for 6-16V input

Voltage (V)	Average Current (mA)	Peak Current (mA)
6	273	308
8	251	292
10	219	273
12	167	211
14	144	178
16	128	158

TouchSecure® Mullion User Manual

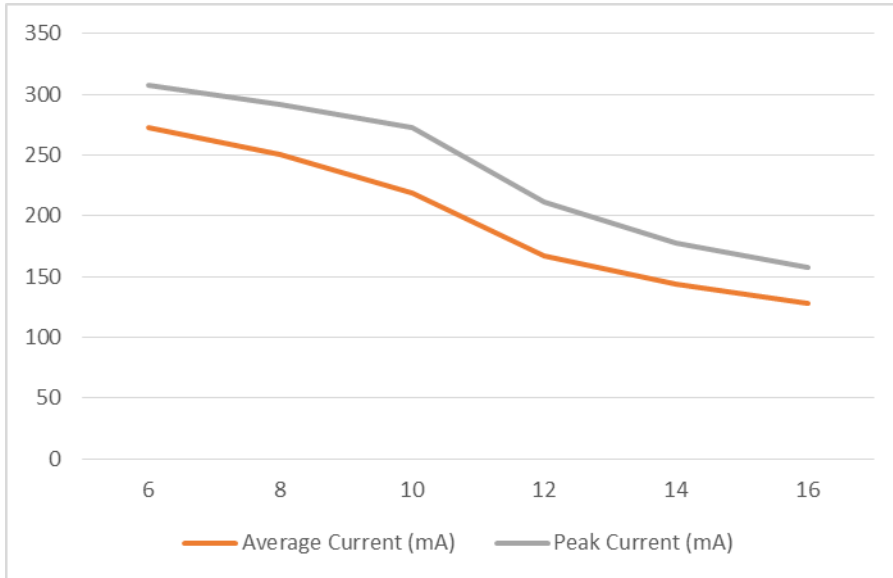

4.1.3.2 Rated current for POE

Voltage (V)	Average Current (mA)	Peak Current (mA)
37	65	70
48	50	55
57	45	50

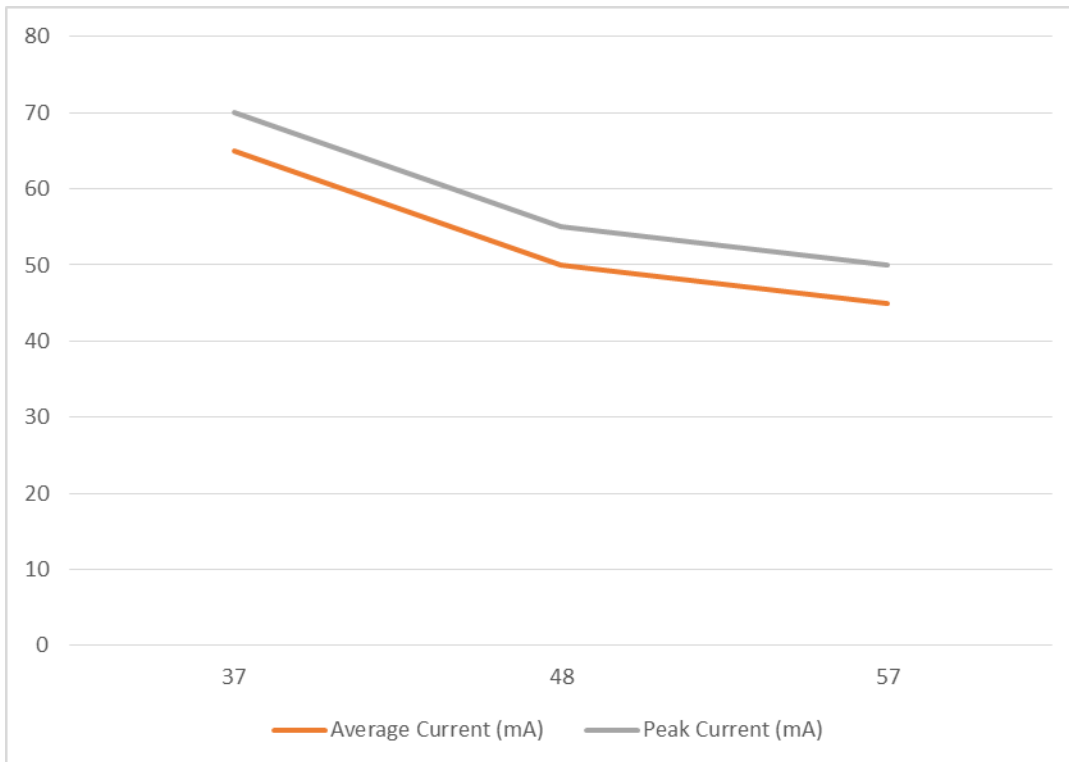

TouchSecure® Mullion User Manual

5.0 Installation details

Wiring methods shall be in accordance with the National Electrical Code (ANSI/NFPA70), local codes, and the authorities having jurisdiction.

5.1 Parts List

- TouchSecure®reader -1
- Screws (A #6-18X1.5" SS) - 2Nos – Mounting screws for Wall
- Snake Eye Screw (SMF #6-32X5/16" SS) – Top casing mounting security screw
- Screws (SMF #6-32x3/8" SS) - 3 No's - 1 Top casing mounting screw and 2 Junction Box mounting screws
- Nylon anchor plug -2 Nos
- 6 pin phoenix plug (Phoenix connector version only) – 2 Nos

5.2 Recommended Infrastructure

- All cabling and wiring shall be UL Listed and/or UL Recognized
- All readers shall be powered by UL listed POE sourcing equipment, UL listed power-limited power supply, or power-limited output from UL listed control panel
- There shall be no connections made to the RS-485 interface (RS485+ and RS485-) for UL installations
- Cable Wiegand - 22AWG Shielded cable. (Cable P No : ALPHA WIRE, P/N 1299/10C)
- Cable RS485 - RS485 for 1000m** (4000ft) 24AWG STP
- Cable RJ45 - Cat5e / Cat6
- Linear DC PS - 5-16 V, 1A min.

** Tested in lab conditions up to 115Kbaud

5.3 Wiring Information

5.3.1 Cable Color codes for Pig Tail Reader













Red &	+ VDC 12V (nominal)	
Black & White	Ground	
Green	Wiegand Data 0	
White	Wiegand Data 1	
Orange	Green LED	
Yellow	Buzzer	
Blue	Hold	
Brown	Red LED	
Grey	RS485 -	
Pink	RS 485 +	
Violet	Tamper Output	
Black / Drain	Shield Ground	

Table 2

& - Do not connect when reader is powered by Power over Ethernet

5.3.2 Pin out for Phoenix Connector Reader

TouchSecure® Mullion User Manual

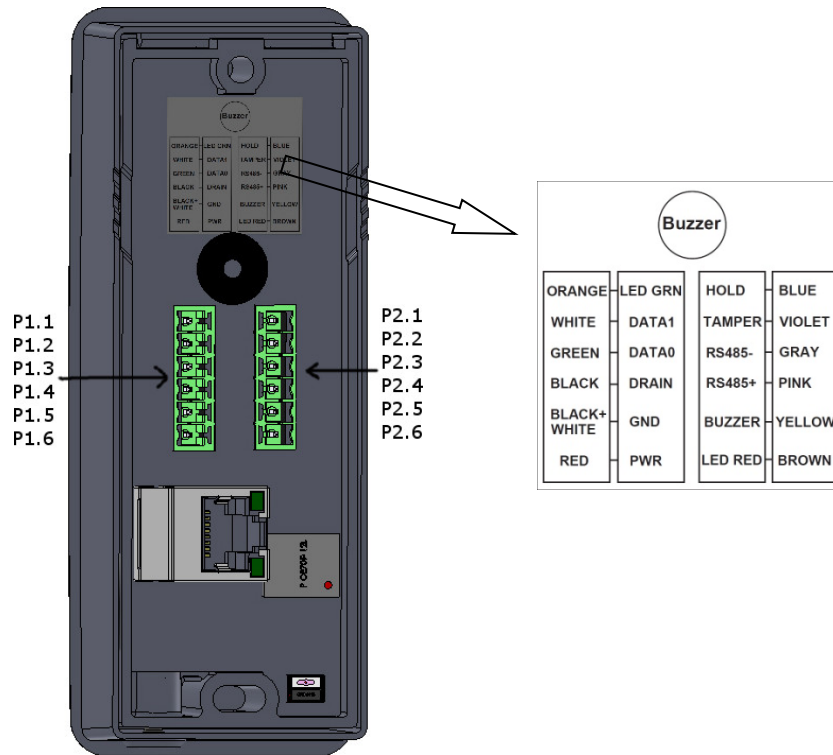

Pin	Cable color	Description	Comment
P1.1	Orange	LED Green	
P1.2	White	Data 1	
P1.3	Green	Data 0	
P1.4	Black	Drain	Drain to be connected to cable shield
P1.5	Black + White	Gnd	
P1.6	Red	Power	Do not connect when reader is powered by PoE
P2.1	Blue	Hold	
P2.2	Violet	Tamper	
P2.3	Gray	RS485-	
P2.4	Pink	RS485+	
P2.5	Yellow	Buzzer	
P2.6	Brown	LED Red	

Table 3

Caution:

During Wiring make sure that the +VDC lines does not make contact with any other cables, as it might affect reader functionality/ cause damage to the reader.

5.4 Mounting the Reader

5.4.1 Location of mounting holes on wall

TouchSecure® Mullion User Manual

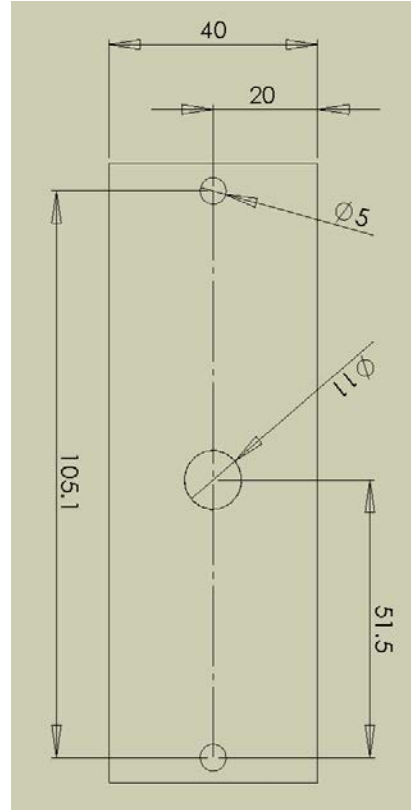
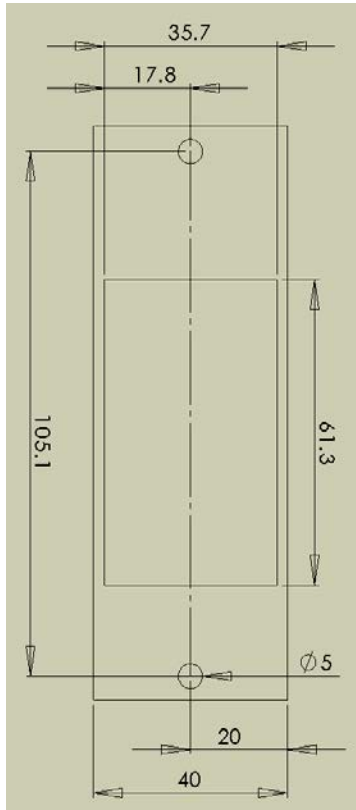

Phoenix connector Reader – 2 Holes and 1 Slot

Pig Tail Reader – 3 Holes

5.4.2 Reader Installation Steps

- Make two holes on the wall as per the image above corresponding to the type of reader.
- Insert the nylon screw plugs into the wall.
- Connect the wires as per the Table 2 or Table 3.
- TouchSecure® reader with Bottom Casing is to be now secured onto the wall using the Screws (A #6-18X1.5" SS)
- The top casing can be inserted onto the bottom casing
- Secure the Top and bottom casing by the Snake Eye Screw (SMF #6-32X5/16" SS)

TouchSecure® Mullion User Manual

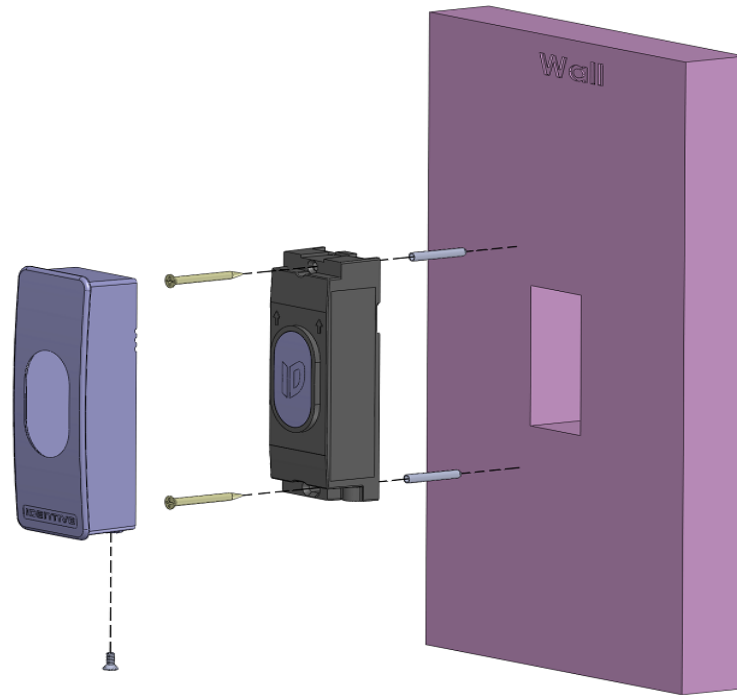

Reader Installation Steps - Phoenix Connector Version

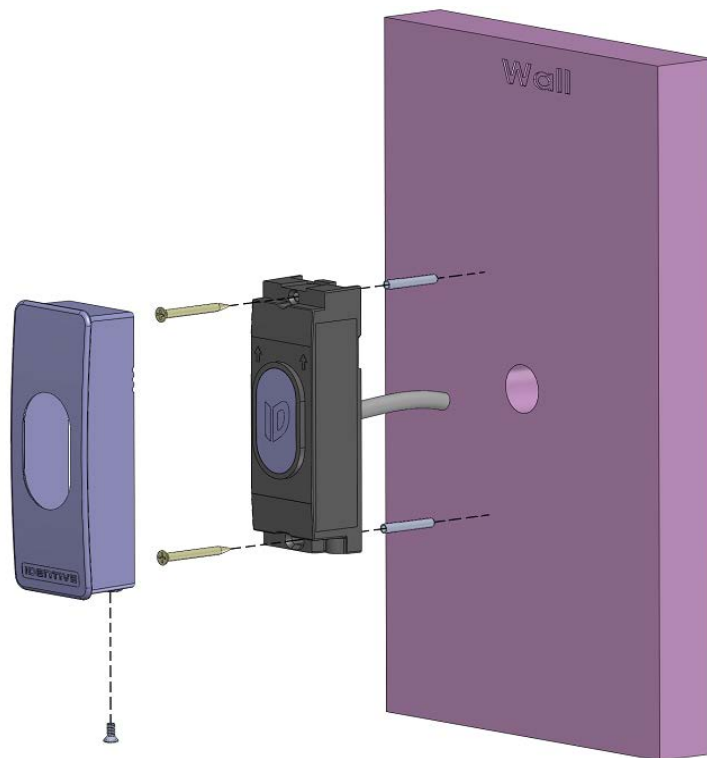

Reader Installation Steps - Pig Tail Version

TouchSecure® Mullion User Manual

5.5 Power up and Testing

- 1 **Turn power on**
The LED blinks 3 times green with a long beep, then turns red
- 2 **Present a card**
The LED blinks green, and a short Beep is emitted

This is the default reader behavior.



6.0 Certifications

6.1 FCC

This equipment has been tested and found to comply with the limits for a Class B digital device, pursuant to part 15 of the FCC Rules. These limits are designed to provide reasonable protection against harmful interference in a residential installation. This equipment generates uses and can radiate radio frequency energy and, if not installed and used in accordance with the instructions, may cause harmful interference to radio communications. However, there is no guarantee that interference will not occur in a particular installation. If this equipment does cause harmful interference to radio or television reception, which can be determined by turning the equipment off and on, the user is encouraged to try to correct the interference by one or more of the following measures:

- Reorient or relocate the receiving antenna.
- Increase the separation between the equipment and receiver.
- Connect the equipment into an outlet on a circuit different from that to which the receiver is connected.
- Consult the dealer or an experienced radio/TV technician for help.

Information to user

Changes or modifications not expressly approved by *Identive could* void the user's authority to operate the equipment.

6.2 IC

This Class B digital apparatus complies with Canadian ICES-003.
This device complies with Industry Canada licence-exempt RSS standard(s).
Operation is subject to the following two conditions:
(1) This device may not cause interference
(2) This device must accept any interference, including interference that may cause undesired operation of the device.

6.3 CE

Identive hereby declares that the TouchSecure® Model: Connectivity MUL device mentioned herein is in compliance with the essential requirements and other relevant portions of the Directive R&TTE 1999/5/EC.



TouchSecure® Mullion User Manual

6.4 UL 294

- Communication via Wiegand was evaluated by UL and serves as the interface between the reader and panel
- Communication via RS485 or OSDP is not permitted
- Communication via Ethernet was not evaluated by UL
- The maximum length of the Ethernet cable when using POE as the power source in UL installations is limited to 30 meters (98.5 feet)

6.4.1 UL 294 access control performance levels

Destructive attack	: Level IV
Line Security	: Level I
Endurance	: Level I
Standby Power	: Level I